

**M&T**  
METERING & TECHNOLOGY

# HTM Series Helical Turbine Meters



# HTM Series - Helical Turbine Meters

The HTM series of turbine meters is designed for high accuracy volume measurement of crude oils and other liquid hydrocarbons.

M&T helical turbine meters are preferred for their high robustness and performance on liquid hydrocarbons custody transfer such as Export loading terminals, FPSOs, pipelines, separators.

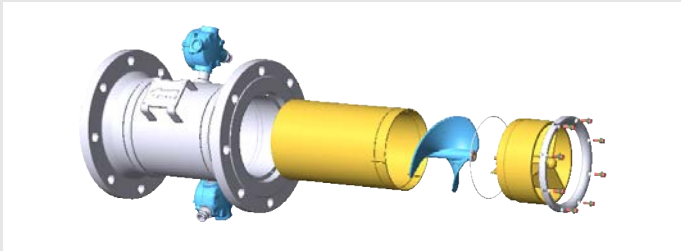

## Features & Benefits

- Low to high viscosity design for single or multi-viscosity metering applications with stable meter factors
- Superior linearity and repeatability
- Counting starts from close to zero flow
- Helical rotor protected against severe corrosion
- Helical rotor rounded front profile for meter performance stability when fibres or contaminants are present in crude oil
- 3 part special design self cleaning tungsten carbide bearings for long life
- Stainless Steel interchangeable measurement cartridge for easy site maintenance and downtime reduction
- Special materials available (Duplex, Hastelloy, Inconel)
- Low pressure drop



## Applications

- FSO & FPSO custody transfer (crude oil)
- On and Offshore allocation metering (crude oil, condensates)
- Pipeline metering stations (crude oil, refined products)
- Tanker loading/offloading terminals (crude oil, refined products, petrochemicals)
- Storage management (crude oil, refined products, petrochemicals)



## Design

The turbine meter consists of a dual-helical blade rotor that rotates proportionally to the volume of liquid flowing through the meter. Small magnets in each blade cause the sensors to switch state every time a rotor blade passes. Two sensors at a  $135^\circ$  angle are normally fitted. The rotor is located in a pressure balanced measuring chamber that is maintained in the flow meter body by means of a screwed retaining ring.

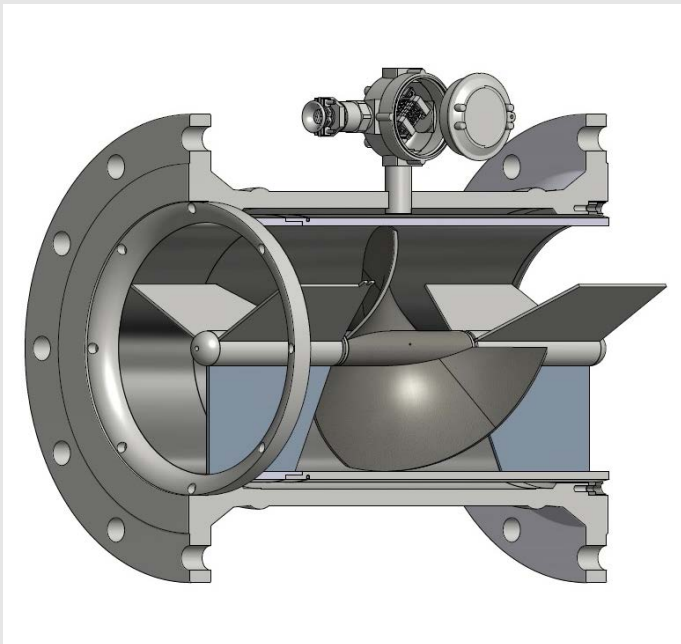

Every pulse generated by the sensor corresponds to a volume value or pulse weight.

The nominal number of pulses per volume unit (K-Factor) depends on the meter size and is accurately determined during flow meter calibration (laboratory proving or field proving).

All internal parts are designed and tested using advanced FEA & CFD tools for optimal development of all mechanical parts which influence the helical turbine meter performance.



## Performance Reliability

- Cross-plates supporting the HTM rotors are welded to the two part measuring chamber system. This ensures perfect bearing set alignment to ensure that friction is minimised for the best measurement performance.
- Unlike other turbine assembly systems, the HTM measuring chamber can be removed and then re-installed without need of recalibration.
- The tungsten carbide grade for the bearings is carefully selected to minimize erosion - even in harsh conditions such as sand content in hydrocarbons.
- The shaft is lubricated by means of small ducts embedded in the bearing pockets, preventing the accumulation of particles or paraffin that could increase friction.



# HTM Performance & Technical Data

## HTM performance against conventional turbine meter

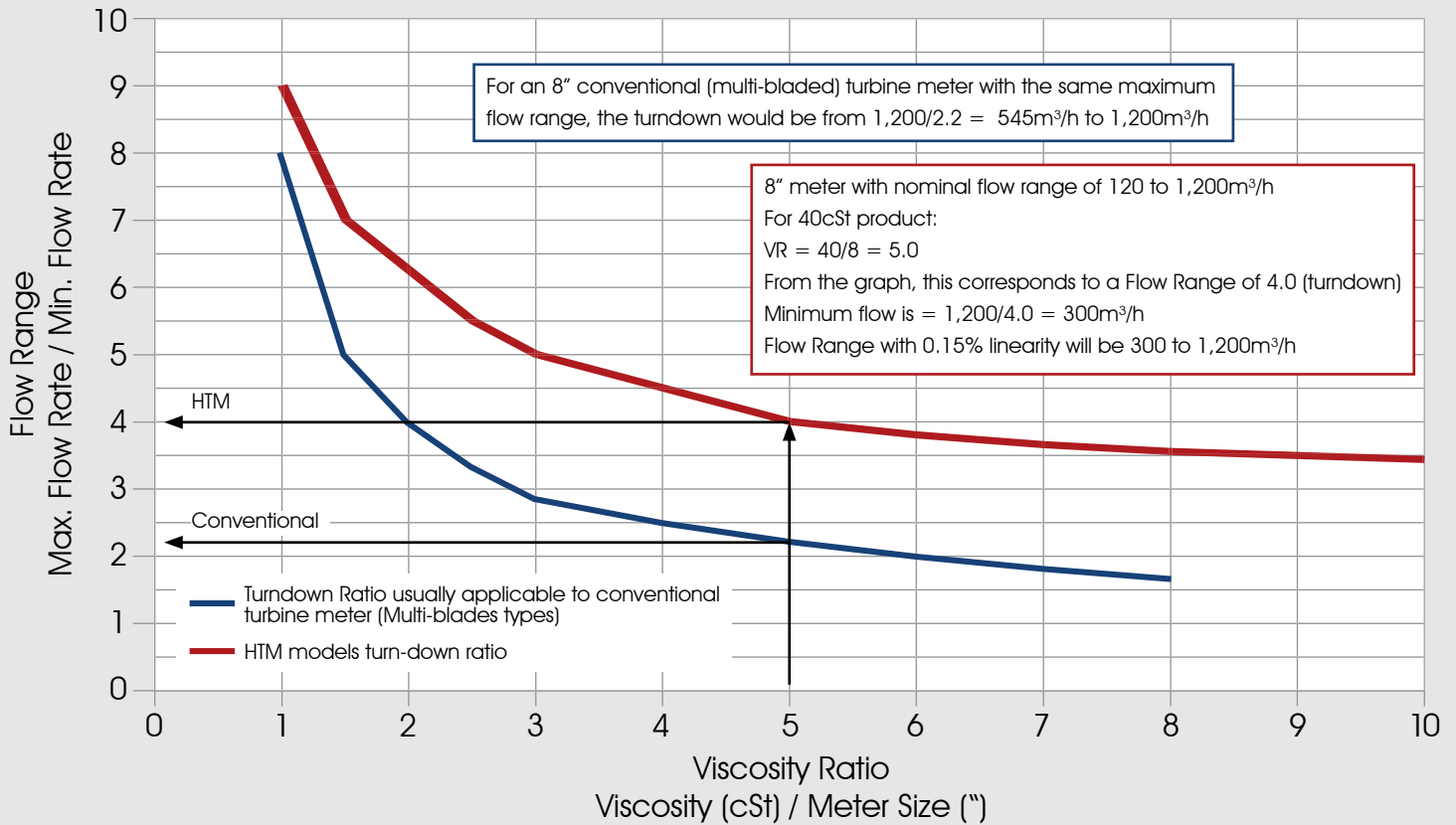

Flow Range at +/-0.15% linearity & +/-0.02% repeatability vs Viscosity Ratio

## Nominal Flow Ranges

Type	Meter Size		Flow Rate ( $\text{m}^3/\text{h}$ )		Flow Rate (BPH)	
	Inch	mm	Min.	Max.	Min.	Max.
HTM01	1"	25	1.4	14	9	90
HTM015	1½"	40	3.4	34	21	210
HTM02	2"	50	6	60	38	380
HTM03	3"	80	15	150	94	940
HTM04	4"	100	30	300	189	1890
HTM06	6"	150	60	600	377	3770
HTM08	8"	200	120	1200	755	7550
HTM10	10"	250	200	2000	1258	12580
HTM12	12"	300	300	3000	1887	18870
HTM16	16"	400	400	4000	2516	25160

See Note 1

## Length & Weight

Type	Meter Length		Weight (kg)			Weight (lb)		
	Inch	mm	#150	#300	#600	#150	#300	#600
HTM01	5½"	140	8	9	10	18	20	22
HTM015	6½"	165	12	14	15.5	26	31	34
HTM02	6½"	165	15	16.5	19	33	36	42
HTM03	10	254	25	29	33	54	64	73
HTM04	12	305	38	51	63	84	113	139
HTM06	14	356	42	59	83	93	131	184
HTM08	16	406	74	98	139	162	216	307
HTM10	20	508	108	147	224	239	324	494
HTM12	24	610	182	234	304	400	515	670
HTM16	32	813	289	392	489	636	864	1077

See Note 2

Note 1 - Extended flow ranges may be available depending on your process conditions. Please contact us for more details.

Note 2 - Other weights for #900, #1500 & #2500 available upon request (given lengths are for face to face flanges).



# Calibration Curves

## HTM 16" Universal Performance Curve example

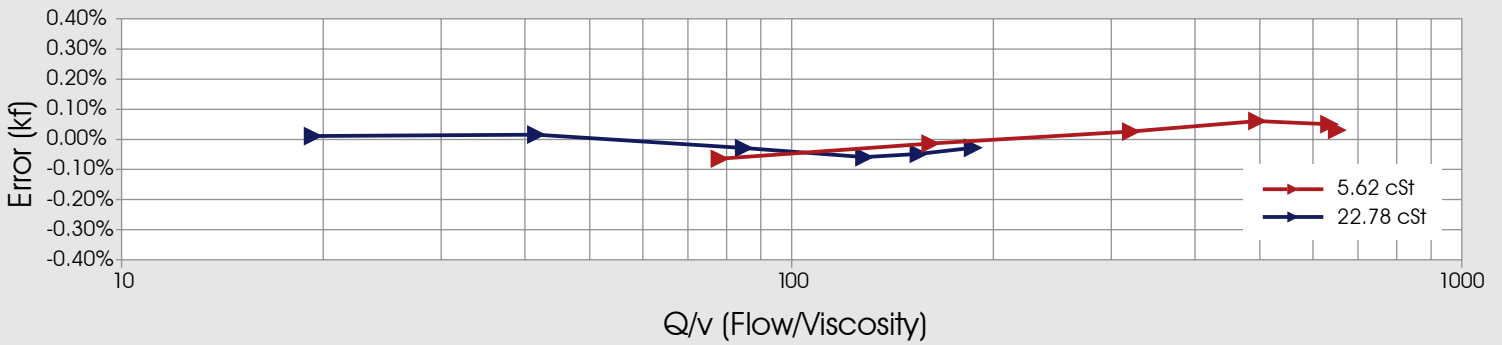

## HTM 16" Master Meter calibrated better than +/-0.1% linearity on 2 products

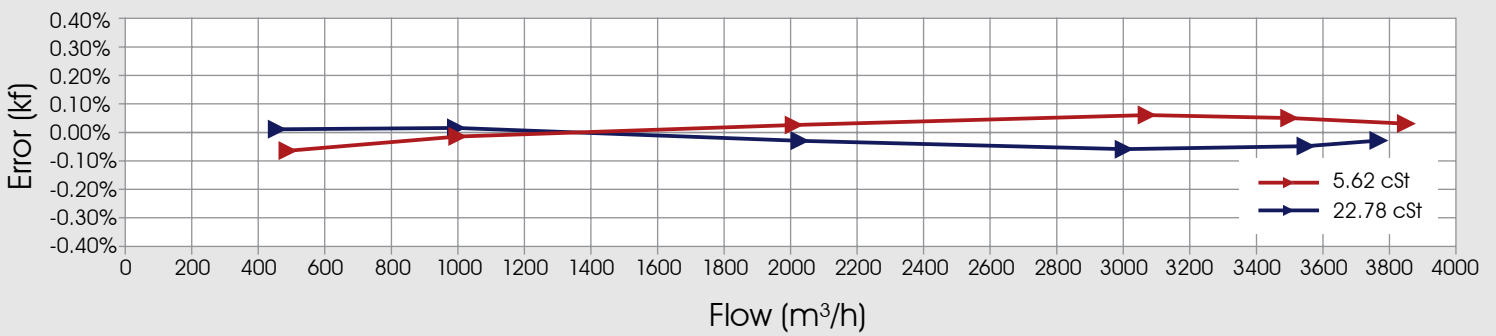

## HTM 6" Master Meter calibrated better than +/-0.04% on jet fuel

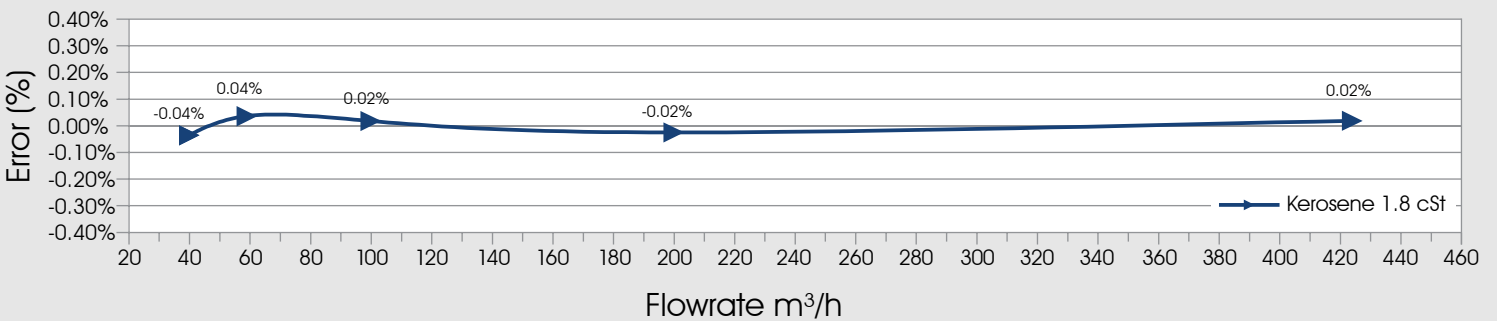

## HTM 10" Master Meter calibrated better than +/-0.1% at 17 cSt light crude

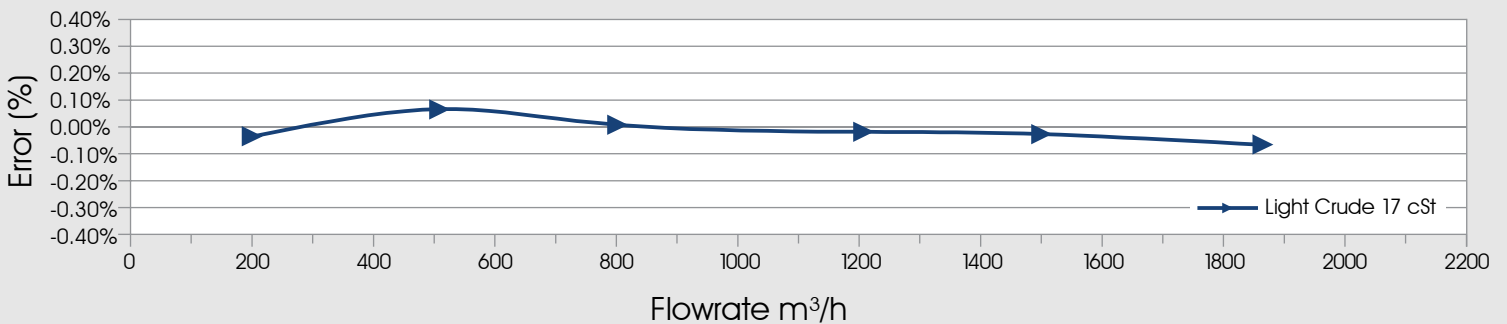

# Specifications

## Metrology

Compliances	OIML R117-1 class 0.3 API MPMS ch5.3 MID 2004/22/EC GOST
Accuracy	+/- 0.15% of the measured value (standard) up to +/- 0.1% on single viscosity use (premium)
Repeatability	Better than +/- 0.02%
Installation	7D upstream with recommended flow conditioner + 5D downstream

## Certifications

Safety	ATEX 94/9/EC II 2 G Exd IIC T6..T3 Gb
Pressure	PED 97/23/EC ASME B31.3
Metrology	OIML R117-1 (PTB-1.5-4035948) GOST SIRIM (ATS 05/10) MIGAS (14599/18.06/DMT/2009) SPRING (WMO 423/08) INMETRO (P-0004-11-054524-10)
Environment	EMC 89/336/EC
Ingress Protection	IP 66/67 IEC529

## Process

Temperature	Process: -40°C to +150°C Ambient: -40°C to +150°C
Pressure	According to flange pressure rating
Viscosity	0.2 to 120 cSt (higher upon request)
Density	400 to 1500 kg/m <sup>3</sup>

## Body

Materials	Carbon steel, low temp carbon steel, stainless steel, duplex, super duplex stainless steel
Flanges	ANSI 150, 300, 600, 900, 1500, 2500
Sensor Enclosure	SS 316L

## Sensor

Type	MR 3-wire open drain with integrated pull-up resistor
Input Voltage/Current	6 to 24 Vdc/13mA typical to 20mA max
Output Current	20mA max
Junction Box	Copper free aluminium (std), SS 316L
Connection	¾" NPT, M20
Optional	2-wire NAMUR

## Measuring Chamber

2 Parts Assembly	SS 316L
Bearing System	Shaft, Sleeve & Thurst in Tungsten Carbide
Rotor Design	Helicoidal type with rounded front profile
Rotor Material	Light alloy (Standard) corrosion protected, Stainless Steel, Titanium



# Flow Conditioner (FCS Series)



Flow Conditioners are required for custody transfer and/or when the piping configuration does not permit the installation of long metering runs.

M&T's flow conditioners (FCS series) are designed to ensure constant flow meter performance. Inserted at the upstream end of a 7D upstream spool they have a "top hat" fixing design which minimizes the risk of any materials breaking free and causing downstream damage.

The design is more efficient than a tube bundle design for the elimination of swirl while having a much lower pressure drop.

The chart below can be used to select the correct flow conditioner for your application (if required).

FCS	FCS			Product Line				
	03	3"/DN80		Flow Conditioner Size				
	04	4"/DN100						
	06	6"/DN150						
	08	8"/DN200						
	10	10"/DN250						
	12	12"/DN300						
	16	16"/DN400						
	A	150# ANSI RF Flanges		Pressure Class				
	B	300# ANSI RF Flanges						
	C	600# ANSI RF Flanges						
	D	Other (please contact us)						
			<b>BODY</b>	<b>FLANGES</b>	Spool Piece Construction Materials			
		1	CS A106	CS A105				
		2	LTCS A333 Gr6	LTCS A350 LF2				
		3	SS 316L	SS 316L				
		4	Other	Other				
		1	SS 304 (Standard)		Flow Straightening Vane Material			
		2	SS 316 L (Optional)					
		O	Other (please contact us)					
		AC	Cross plate, removable top hat (Standard)		Vane Type and Mounting			
		O	Other (please contact us)					
		1	7 Diameter long (Standard)		Flow Conditioner Length			
		2	10 Diameter long (Optional)					
		3	Specific					
		1	2 Diameter long (Standard)		Flow Straightening Vane Length			
		O	Other (please contact us)					
FCS	10	A	1	1	AC	1	1	Example Product Code



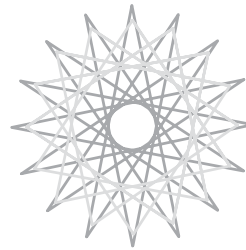

## HTM Series - Ordering Codes

HTM	HTM									Product Line	
↓	01	1"/DN25								Meter Size	
	015	1½"/DN40									
	02	2"/DN50									
	03	3"/DN80									
	04	4"/DN100									
	06	6"/DN150									
	08	8"/DN200									
	10	10"/DN250									
	12	12"/DN300									
	16	16"/DN400									
	↓	A	150# ANSI RF Flanges								Pressure Class
		B	300# ANSI RF Flanges								
		C	600# ANSI RF Flanges								
		D	Other (please contact us)								
	↓			<b>BODY</b>		<b>FLANGES</b>		<b>INTERNALS</b>			Materials of Construction
		1		CS A106 or equ		CS A105 or equ		SS 316L			
2			LTCS A333 Gr6		LTCS A350 LF2		SS 316L				
3			SS 316L		SS 316L		SS 316L				
↓	4		Other		Other		Other				
	1		Light alloy (Standard)						Rotor Material		
	2		Titanium								
3		Stainless Steel									
↓	1		1 Pick off with integral preamplifier						Sensor		
	2		2 Pick offs with integral preamplifier								
	3		3 Pick offs with integral preamplifier								
↓	0		Without						Flow Conditioning Element*		
	1		With								
↓	0		None						Electronic Register		
	1		Local								
	2		Remote								
↓	0		None						Documentation		
	1		Standard								
	2		Customised								
↓	0		None						Special Request**		
	S		Special Request								
HTM	12	A	1	1	2	1	0	1	0	Example Product Code	

\* Please refer to previous page for Flow Conditioner information

\*\* Upstream and downstream lengths can be provided upon request

